

23765
VILLA YAN SEHPA
BEYAZ & KIRÇILLI

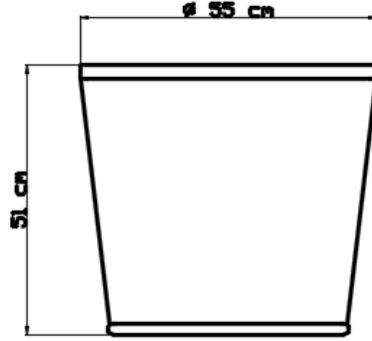
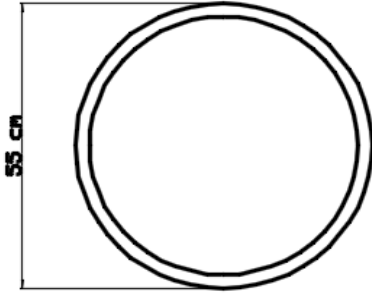

BOYUT

BOYUT Ø 55 x 51 cm HT.

CAM ÖLÇÜSÜ Ø 47.8 insert cm

CAM KALINLIĞI 6mm

ÖZELLİKLER

ÇERÇEVE 1 piece

BRÜT AĞIRLIK 4,84 Kg

HACİM 0,16 m3

CAM TABLA 1 piece

BRÜT AĞIRLIK 3,80 Kg

HACİM 0,01 m3

DETAYLAR



ÖRGÜ

Beyaz & kırçilli
Mushroom N-Profile
15mm



KAPLAMA

Beyaz



TABLA

Boyalı
temperli cam



KORUYUCU KILIF İLE KULLANILMASI ÖNERİLİR



SUYA DAYANIKLI



ÇEVRE DOSTU

MALZEME & BAKIM

Örgü: Polyethylene UV korumalı

Çerçeve: Elektrostatik toz boya kaplı

Çerçeve bakımı: Hortum yardımı ile yıkanabilir. , Eğer çok kirliyse sabun yardımı ile temizlenebilir.

23763 VILLA KANEPE

BEYAZ & KIRÇILLI

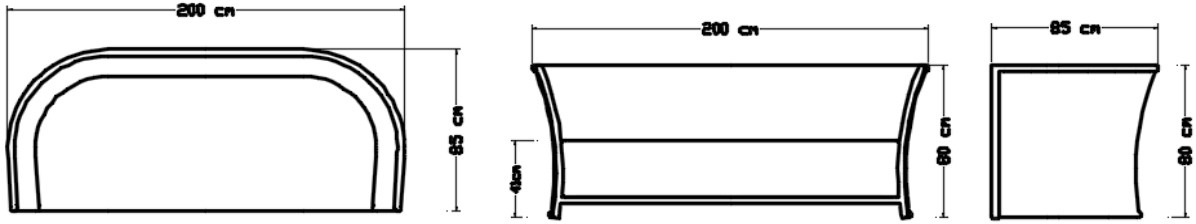

BOYUT

BOYUT 200 x 85 x 80 cm HT.
KOL YÜKSEKLİĞİ 80 cm
OTURUM YÜKSEKLİĞİ 41 cm
OTURUM GENİŞLİĞİ 178 cm
OTURUM DERİNLİĞİ 72 cm

ÖZELLİKLER

ÇERÇEVE 1 piece
BRÜT AĞIRLIK 20,60 Kg
HACİM 1,40 m³
MİNDER 1 set
BRÜT AĞIRLIK 13,89 Kg
HACİM 0,69 m³

DETAYLAR

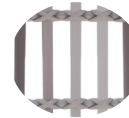

ÖRGÜ

Beyaz & Kırçilli
Mushroom N-Profile
15mm



KAPLAMA

Beyaz

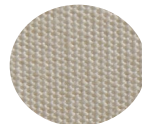

MİNDER

Canvas Velum
5498

MALZEME & BAKIM

Örgü: Polyethylene UV korumalı

Çerçeve: Elektrostatik toz boya kaplı

Çerçeve bakımı: Hortum yardımı ile yıkanabilir. , Eğer çok kirliyse sabun yardımı ile temizlenebilir.

Minder bakımı :Bütün minder kılıfları fermuarlıdır.ve kolay çıkartılabilme özelliğine sahiptir.30 derecede makinede yıkanabilir.Ağartıcı kullanılması önerilmez.

OPSİYONEL

BU koleksiyon aşağıdaki renklerde üretilebilir

SUILVER WALNUT MUSHROOM

NARURAL RATTAN

Kumaş

SUNBRELLA COLLECTION



KORUYUCU KILIF İLE KULLANILMASI ÖNERİLİR



SUYA DAYANIKLI



ÇEVRE DOSTU

VILLA COLLECTION KANEPE

23761 VILLA TEKLİ KOLTUK

BEYAZ & KIRÇILLI

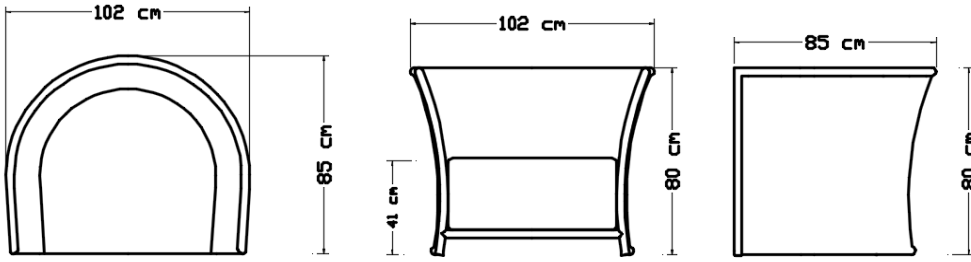

BOYUT

BOYUT 102 x 85 x 80 cm HT.
KOLYÜKSEKLİĞİ 80 cm
OTURUM YÜKSEKLİĞİ 41 cm
OTURUM GENİŞLİĞİ 72 cm
OTURUM DERİNLİĞİ 72 cm



KORUYUCU KILIF İLE KULLANILMASI ÖNERİLİR



SUYA DAYANIKLI



ÇEVRE DOSTU

ÖZELLİKLER

ÇERÇEVE 1 piece
BRÜT AĞIRLIK 12,50 Kg
HACİM 0,72 m³
MİNDER 1 set
BRÜT AĞIRLIK 5,11 Kg
HACİM 0,32 m³

MALZEME & BAKIMI

Örgü: Polyethylene UV korumalı

Çerçeve: Elektrostatik toz boya kaplı

Çerçeve bakımı: Hortum yardımı ile yıkanabilir. , Eğer çok kirliyse sabun yardımı ile temizlenebilir.

Minder bakımı: Bütün minder kılıfları fermuarlıdır.ve kolay çıkartılabilme özelliğine sahiptir.30 derecede makinede yıkanabilir.Ağartıcı kullanılması önerilmez.

DETAYLAR



ÖRGÜ

Beyaz & Kırçilli
Mushroom N-Profile
15mm



KAPLAMA

Minder

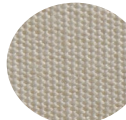

MİNDER

Canvas Velum
5498

OPSİYONEL

Bu koleksiyon aşağıdaki renklerde üretilebilirç

SUILVER WALNUT MUSHROOM

NARURAL RATTAN

Kumaş

SUNBRELLA COLLECTION

VILLA COLLECTION TEKLİ KOLTUK

23766
VILLA PUF
BEYAZ & KIRÇILLI

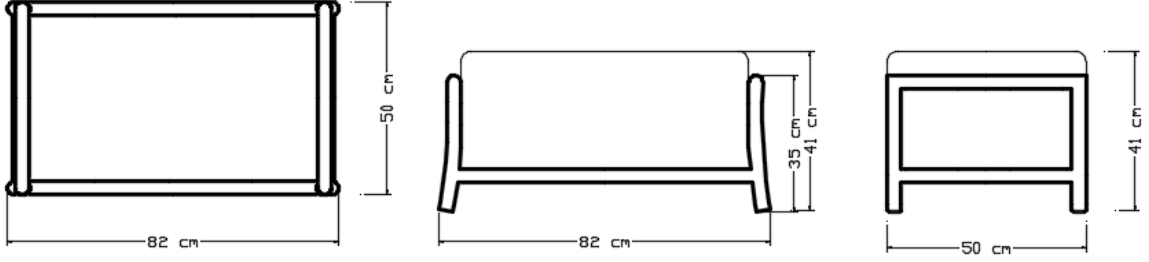

BOYUT

BOYUT 82 x 50 x 35 cm HT
.KOL YÜKSEKLİĞİ
OTURUM YÜKSEKLİĞİ 41 cm
OTURUM GENİŞLİĞİ 73 cm
OTURUM DERİNLİĞİ 51 cm

ÖZELLİKLER

ÇERÇEVE 1 piece
BRÜT AĞIRLIK 4,92 Kg
HACİM 0,10 m3
MİNDER 1 piece
BRÜT AĞIRLIK 2,50 Kg
HACİM 0,18 m3

DETAYLAR

ÖRGÜ
Kırçilli & Beyaz
Mushroom N-Profile
15mm

KAPLAM
White Wash

MİNDER
Canvas Velum
5498

VILLA COLLECTION PUF



KORUYUCU KILIF İLE KULLANILMASI ÖNERİLİR



SUYA DAYANIKLI



ÇEVRE DOSTU

MALZEME & BAKIM

Örgü: Polyethylene UV korumalı

Çerçeve: Elektrostatik toz boya kaplı

Çerçeve bakımı: Hortum yardımı ile yıkanabilir. , Eğer çok kirliyse sabun yardımı ile temizlenebilir.

Minder bakımı :Bütün minder kılıfları fermuarlıdır.ve kolay çıkartılabilme özelliğine sahiptir.30 derecede makinede yıkanabilir.Ağartıcı kullanılması önerilmez.

23764

VILLA OVAL SEHPA

BEYAZ& KIRÇILLI

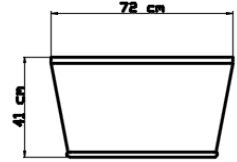
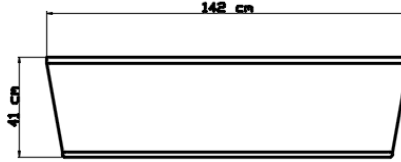
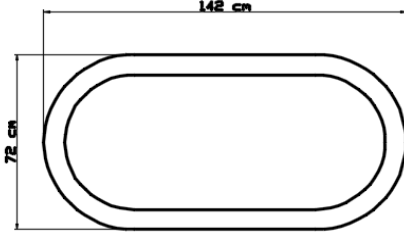

BOYUT

BOYUT 142 x 72 x 41 cm HT.
CAM ÖLÇÜSÜ 134.8 x 64.8 insert cm
CAM KALINLIĞI 6mm

ÖZELLİKLER

ÇERÇEVE 1 piece
BRÜT AĞIRLIK 12,12 Kg
HACİM 0,44 m3
CAM TABLA 1 piece
BRÜT AĞIRLIK 14,40 Kg
HACİM 0,04 m3

DETAYLAR



ÖRGÜ
Beyaz & Kırçilli
Mushroom N-Profile
15mm



KAPLAMA
Beyaz



TABLA
Boyalı
temperli cam



KORUYUCU KILIF İLE KULLANILMASI ÖNERİLİR



SUYA DAYANIKLI



ÇEVRE DOSTU

MALZEME & BAKIM

Örgü: Polyethylene UV korumalı

Çerçeve: Elektrostatik toz boya kaplı

Çerçeve bakımı: Hortum yardımı ile yıkanabilir. , Eğer çok kirliyse sabun yardımı ile temizlenebilir.